

# BEYOND SPEED-DATING

“HOW TO GET THE INTERVIEW AND WIN THE JOB.”

- THE GUYS FROM READROUTE, AKA DAVID & TIMOTHY

THEY WANT YOU.  
WANT THEM TOO?

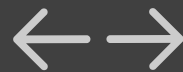

HOW DO YOU DO?  
THE INTERVIEW.

WHAT IS IMPORTANT.  
WHY IS IMPORTANTER.

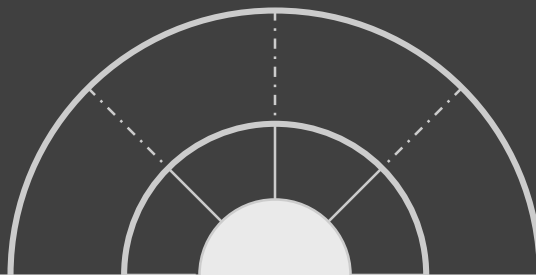

GROW, GROW, GROW,  
YOUR BOAT.



jessicadeblock

Following



1,922 posts

14.2k followers

1,302 following

JESSICA DE BLOCK | JSSC 💡 Proud owner of @antwerpavenue 📅 Full time goal digger 📍 Artist - Graphic Designer ↔ Instagram Strategist 📧  
Jessica@antwerpavenue.com [www.antwerpavenue.com/collections/capsule-collection](http://www.antwerpavenue.com/collections/capsule-collection)

“I WANT TO MAKE THE WORLD  
A PINKER PLACE”

- JESSICA, PINK CELL PHONE CASE MAKER

THEY WANT YOU.  
WANT THEM TOO?

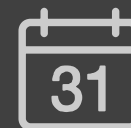
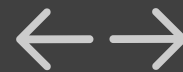

HOW DO YOU DO?  
THE INTERVIEW.

WHAT IS IMPORTANT.  
WHY IS IMPORTANTER.

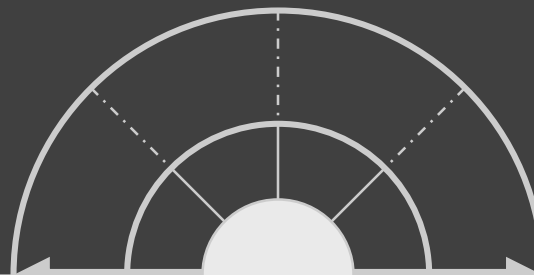

GROW, GROW, GROW,  
YOUR BOAT.



**“I WANNA SELL DRUGS.  
WANT SOME COFFEE?”**

**- JUNGLE FEVER**

**THEY WANT YOU.  
WANT THEM TOO?**

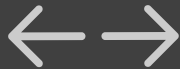

**HOW DO YOU DO?  
THE INTERVIEW.**

**WHAT IS IMPORTANT.  
WHY IS IMPORTANTER.**

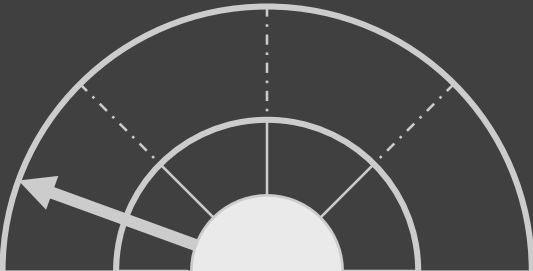

**GROW, GROW, GROW,  
YOUR BOAT.**

# “MY FAVOURITE POSITION IS CEO.”

- FASTFORWARDAMY

THEY WANT YOU.  
WANT THEM TOO?

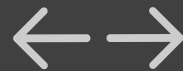

HOW DO YOU DO?  
THE INTERVIEW.

WHAT IS IMPORTANT.  
WHY IS IMPORTANTER.

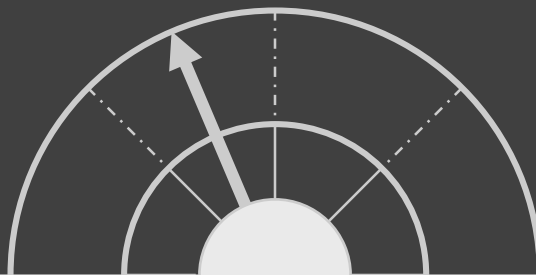

GROW, GROW, GROW,  
YOUR BOAT.

# “I ALWAYS WANT TO BE MORE THAN A PIECE OF PAPER”

- DAVID, MORE THAN A PIECE OF PAPER

THEY WANT YOU.  
WANT THEM TOO?

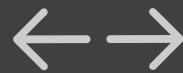

HOW DO YOU DO?  
THE INTERVIEW.

WHAT IS IMPORTANT.  
WHY IS IMPORTANTER.

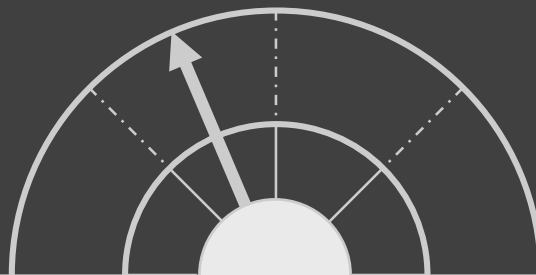

GROW, GROW, GROW,  
YOUR BOAT.

# “I’M NEVER AGAIN TAKING THE STAIRS BEFORE AN INTERVIEW ”

- TIMOTHY, DOUBLE STAIR STEPPER

THEY WANT YOU.  
WANT THEM TOO?

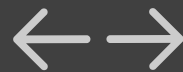

HOW DO YOU DO?  
THE INTERVIEW.

WHAT IS IMPORTANT.  
WHY IS IMPORTANTER.

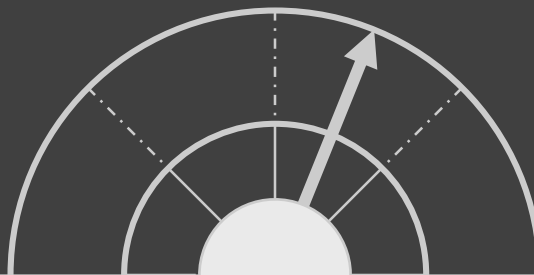

GROW, GROW, GROW,  
YOUR BOAT.

**“REMEMBER THAT A PERSON’S NAME IS TO THAT PERSON THE SWEETEST & MOST IMPORTANT SOUND IN ANY LANGUAGE”**

**- DALE CARNEGIE, A GUY WHO KNEW WHAT HE WAS TALKING ABOUT**

THEY WANT YOU.  
WANT THEM TOO?

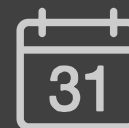
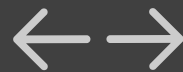

HOW DO YOU DO?  
THE INTERVIEW.

WHAT IS IMPORTANT.  
WHY IS IMPORTANTER.

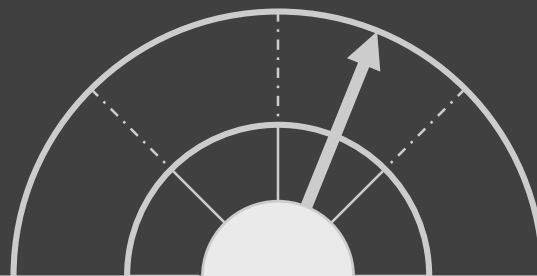

GROW, GROW, GROW,  
YOUR BOAT.

**“I LOVE DEADLINES.  
I LOVE THE SWOOSHING NOISE THEY MAKE AS THEY GO BY.”**

**- DOUGLAS ADAMS, A DEADLINE SWOOSHER**

THEY WANT YOU.  
WANT THEM TOO?

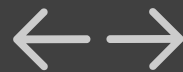

HOW DO YOU DO?  
THE INTERVIEW.

WHAT IS IMPORTANT.  
WHY IS IMPORTANTER.

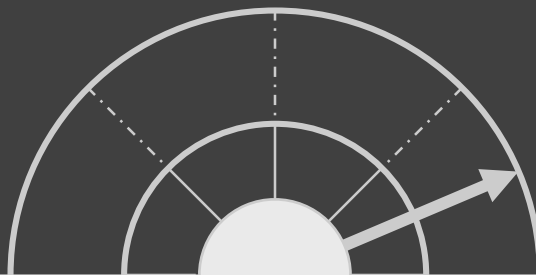

GROW, GROW, GROW,  
YOUR BOAT.



# “THIS JOB IS A SOLID 5 OUT OF 7”

- DAVID, STILL MORE THAN A PIECE OF PAPER.

THEY WANT YOU.  
WANT THEM TOO?

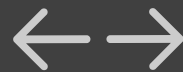

HOW DO YOU DO?  
THE INTERVIEW.

WHAT IS IMPORTANT.  
WHY IS IMPORTANTER.

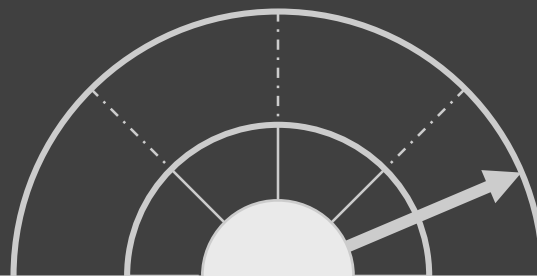

GROW, GROW, GROW,  
YOUR BOAT.

# BEYOND SPEED-DATING

## “HOW TO GET THE INTERVIEW AND WIN THE JOB.”

WWW.READROUTE.COM

### WHAT IS IMPORTANT. WHY IS IMPORTANTER

“I WANT TO MAKE THE WORLD A **PINKER** PLACE”

- JESSICA, PINK CELL PHONE CASE MAKER

“I WANNA SELL DRUGS. WANT SOME COFFEE?”

- JUNGLE FEVER



### THEY WANT YOU. WANT THEM TOO?

“MY FAVOURITE POSITION IS CEO.”

- FASTFORWARDAMY

“I ALWAYS WANT TO BE MORE THAN A PIECE OF PAPER”

- DAVID, MORE THAN A PIECE OF PAPER

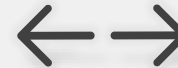

### HOW DO YOU DO? THE INTERVIEW.

“REMEMBER THAT A PERSON’S NAME...”

- DALE CARNEGIE, A GUY WHO KNEW WHAT HE WAS TALKING ABOUT

“I’M NEVER AGAIN TAKING THE STAIRS BEFORE AN INTERVIEW ”

- TIMOTHY, DOUBLE STAIR STEPPER



### GROW, GROW, GROW, YOUR BOAT

“I LOVE DEADLINES.

I LOVE THE SWOOSHING NOISE THEY MAKE AS THEY GO BY.”

- DOUGLAS ADAMS, A DEADLINE SWOOSHER

“THIS JOB IS A SOLID 5 OUT OF 7”

- DAVID, STILL MORE THAN A PIECE OF PAPER.

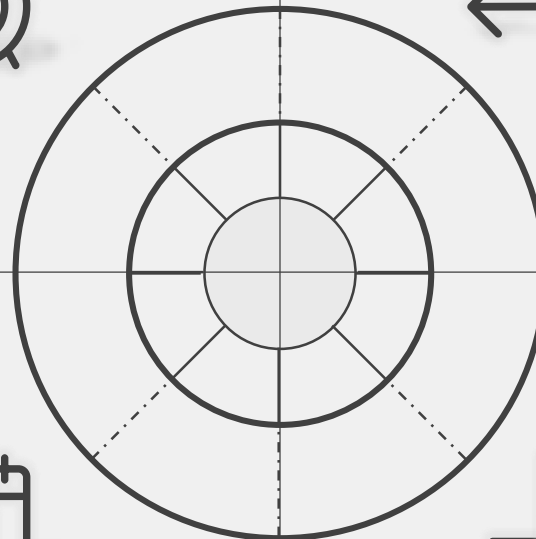

# BEYOND SPEED-DATING

## “HOW TO GET THE INTERVIEW AND WIN THE JOB.”

[WWW.READROUTE.COM](http://WWW.READROUTE.COM)

### WHAT IS IMPORTANT. WHY IS IMPORTANTER

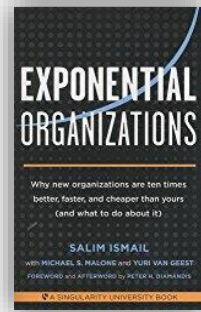
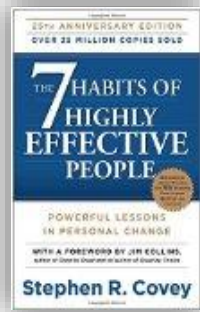
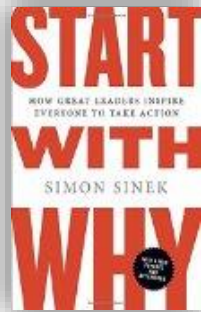

### THEY WANT YOU. WANT THEM TOO?

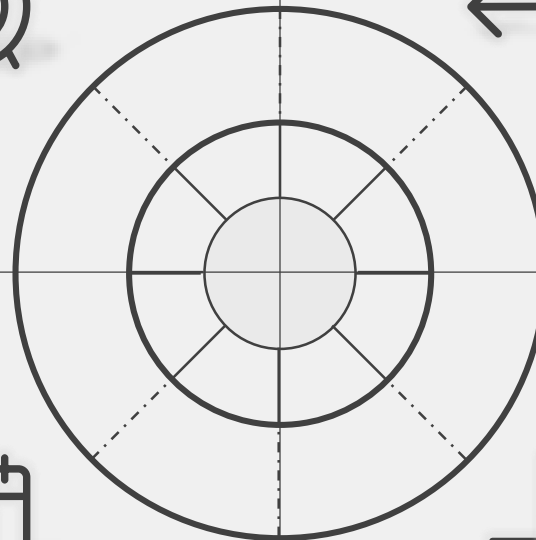
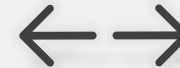
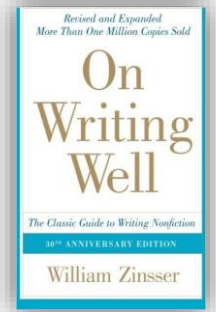
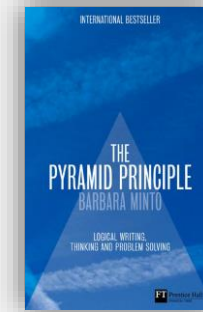

### HOW DO YOU DO? THE INTERVIEW.

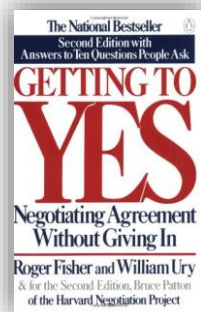
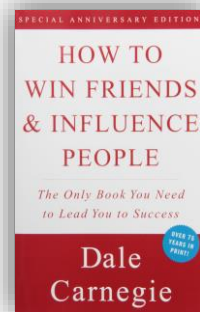
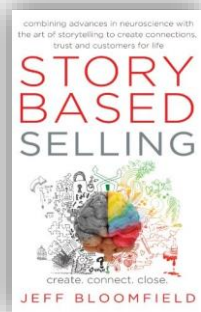

### GROW, GROW, GROW, YOUR BOAT

